

Section 3: Profile Connectors

# Gussets

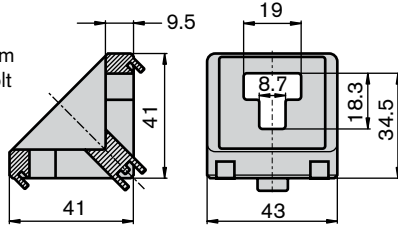

## 45x45 Gusset

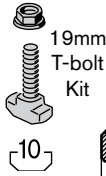
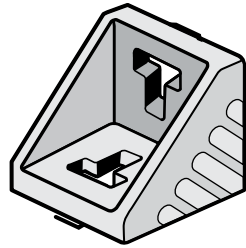

When connecting two profiles with 60mm side dimensions, order offset blocks to help align gusset with outer edge of profiles.

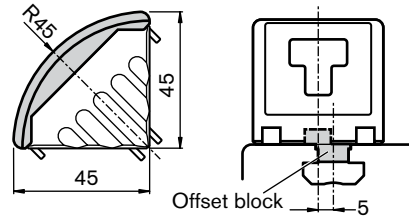

Description	Lot Size	Part Number
45x45 gusset only	1	3 842 523 558
45x45 gusset with fasteners	1	3 842 523 561
45x45 gusset kit with fasteners (includes cover cap) <b>designLINE</b>	1	3 842 538 719
45x45 round cover cap	1	3 842 523 563
Offset block 10mm T-slot-5mm offset	1	3 842 523 593

## 45x90 Gusset

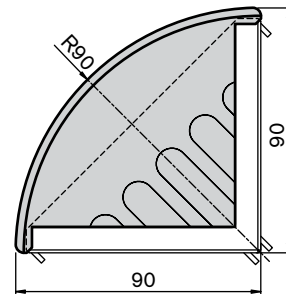
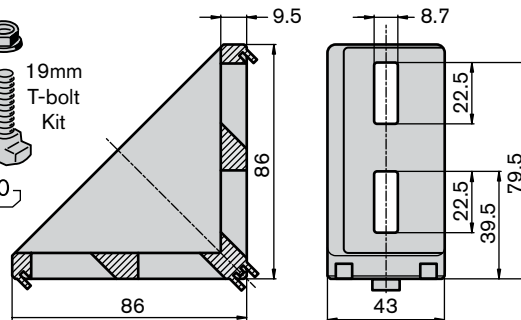
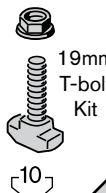
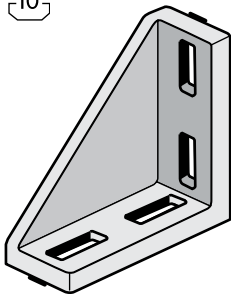

Description	Lot Size	Part Number
45x90 gusset only	1	3 842 523 567
45x90 gusset with fasteners	1	3 842 523 570
45x90 gusset kit with fasteners (includes cover cap) <b>designLINE</b>	1	3 842 538 720
45x90 round cover cap	1	3 842 523 572

GoTo [boschrexroth-us.com/framing](http://boschrexroth-us.com/framing) to get these in stock items **FAST** from your local distributor